



SOT-25



Pin Definition:

1. CTL
2. Ground
3. FLG
4. Input
5. Output

General Description

The TS2023 is integrated 85mΩ high-side power switch for self-powered and bus-powered Universal Serial Bus (USB) applications. This switch operates with input ranging from 3.2V to 6.5V, making it ideal for 5V system.

The protection includes current limiting with foldback, short circuit and thermal shutdown. The TS2023 is ideal for any system where current limiting and power control are desired. The TS2023 has low quiescent current and small package, which is particularly suitable in battery powered portable application. Guaranteed minimum output rise time limits inrush current during hot plug-in as well as minimizing EMI and prevents the voltage at upstream port from dropping excessively.

Features

- 85mΩ High-Side MOSFET Switch
- 1A Continuous Load Current
- 40uA Quiescent Supply Current
- 1uA Maximum Shutdown Supply Current
- 3.2V to 6.5V Input Voltage Range
- Open-Drain Over-Current Flag Output
- Under-Voltage Lockout
- Current-Limit / Short Circuit Protection
- Thermal Shutdown Protection under Over Current Condition
- Under Voltage Lockout Ensures that Switch is off at Start Up
- Soft Start prevents large Inrush Current.
- No Reverse Current when Power off.
- Enable Active-Low

Ordering Information

Part No.	Package	Packing
TS2023CX5 RFG	SOT-25	3Kpcs / 7" Reel

Note: "G" denote for Halogen Free Product

Applications

- USB Power Management
- High-Side Power Protection Switch
- Hot Plug-In Power Supplies
- Battery-Charger Circuits
- Portable Application
- Digital Television

Absolute Maximum Rating

Parameter	Symbol	Limit	Unit
VIN Pin Voltage	V_{IN}	7	V
CTL Input Voltage	V_{CTL}	-0.3 ~ 7	V
Operating Temperature Range	T_{OP}	-40 to +85	°C
Junction Temperature	T_J	+125	°C
Power Dissipation	P_D	350	mW
Storage Temperature Range	T_{STG}	-65 to +150	°C
Thermal Resistance from Junction to case	θ_{JC}	115	°C/W
Thermal Resistance from Junction to ambient	θ_{JA}	250	°C/W

Note: Absolute maximum rating are those values beyond which the life of a device may be impaired

Electrical Characteristics

 ($V_{IN}=5V$, $C_{IN}=C_{OUT}=1\mu F$, $T_A=25^\circ C$, unless otherwise noted)

Characteristics	Symbol	Conditions	Min	Typ	Max	Units
Input Voltage	V_{IN}		3.2	--	6.5	V
Supply Current	I_S		--	40	--	μA
Shutdown Supply Current	I_{SD}	$V_{IN}=3.6V$, $V_{EN}=0V$	--	0.1	1	μA
Current Limit Threshold	I_{LIMIT}		1.1	1.5	2	A
Output MOSFET Resistance	$R_{DS(ON)}$		--	85	--	m Ω
Output Turn-On Rise Time	T_{ON}	$R_{LOAD}=10\Omega$ each output	--	400	--	μS
Output Turn-Off Fall Time	T_{OFF}	$R_{LOAD}=10\Omega$ each output	--	0.7	20	μS
EN Input Threshold	V_{EN}	low-to-high transition	--	--	1.2	V
		High-to-low transition	0.4	--	--	
Output Leakage Current	$I_{LEAKAGE}$	$EN=0$, $V_{OUT}=0V$	--	0.5	1	μA
Over Temperature Shutdown Threshold	OTP	T_J Increasing	--	145	--	$^\circ C$
		T_J Decreasing	--	125	--	$^\circ C$
Under Voltage Lockout	UVLO		--	2.5	--	V
Under Voltage Lockout Hysteresis	$UVLO_{HYSTERESIS}$	$I_{OUT}=0m\sim 150mA$	--	200	--	mV
Over Current Flag Response Delay	FLG_{DELAY}	$V_{OUT}=0V$ until FLG low	4	9	--	mS
FLG Output Low Voltage	$V_{FLG-Low}$		--	--	0.4	V
FLG Off-State Current	$I_{FLG-OFF}$		--	--	1	μA

Note: Specifications are production tested at $T_A=25$. Specifications over the $-40^\circ C$ to $85^\circ C$ operating temperature range are assured by design. Characterization and correlation with statistical quality controls (SQC).

Typical Application Circuit

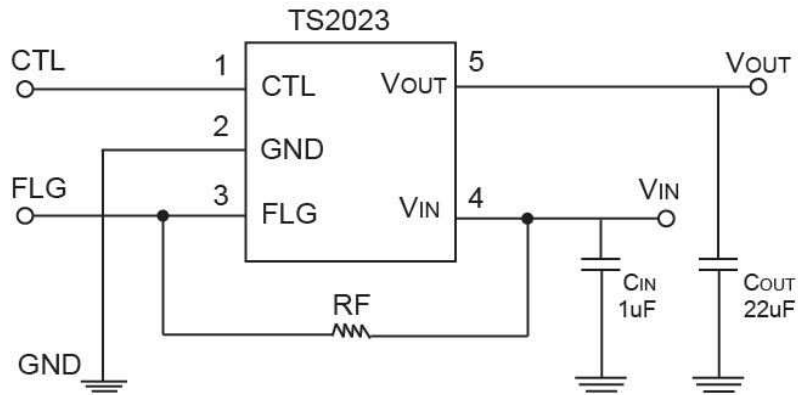

Block Diagram

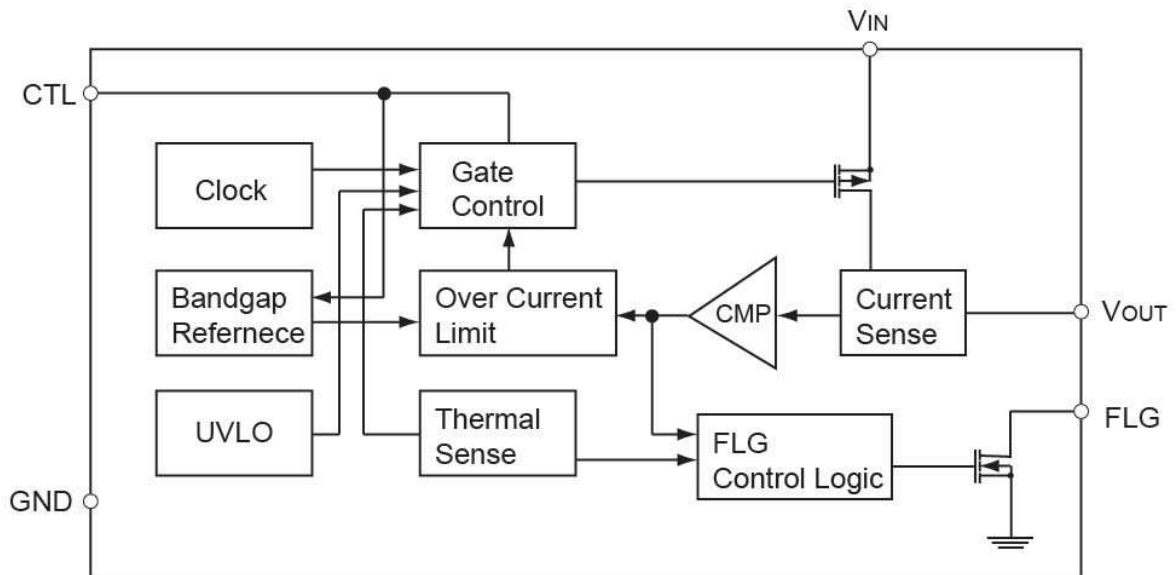

Pin Function Description

Pin NO.	Pin Name	Pin Description
1	CTL	Switch enable
2	GND	Chip power ground
3	FLG	Fault status. A logic low on this pin indicates the switch is in current limit or has been shutdown by the thermal protection circuit
4	VIN	Power supply input
5	VOUT	MOSFET switch output

Application Information

Flag Output

An error Flag is an open-drained output of an N-channel MOSFET. Flag output is pulled low to signal the following fault conditions: input under-voltage, output current limit, and thermal shutdown. The current limit flag response delay time is 9ms.

Current Limit

The current limit threshold is preset internally. It protects the output MOSFET switches from damage resulting from undesirable short circuit conditions or excess inrush current, which is often encountered during hot plug-in. The error flag signals when any current limit conditions occur.

Thermal Shutdown

When temperature of TS2023 exceeds 145°C for any reasons, the thermal shutdown function turns MOSFET switch off and signals the error flag. A hysteresis of 20°C prevents the MOSFETs from turning back on until the chip temperature drops below 125°C.

Enable Control

Enable must be driven logic low for a clearly defined input. Floating the input may cause unpredictable operation

Under-Voltage Lockout

UVLO (under-voltage lockout) prevents the output MOSFET from turning on until input voltage exceeds 2.5V typically. After the switch turns on, if the input voltage drops below 2.3V typically, UVLO shuts off the output MOSFET.

Supply Filtering

A 1uF bypass capacitor from USB IN to GND, located near the device, is strongly recommended to control supply transients. Without a bypass capacitor, an output short may cause sufficient ringing on the input (from supply lead inductance) to damage internal control circuitry

Transient Requirements

USB supports dynamic attachment (hot plug-in) of peripherals. A current surge is caused by the input capacitance of downstream device. Ferrite beads are recommended in series with all power and ground connector pins. Ferrite beads reduce EMI and limit the inrush current during hot attachment by filtering high-frequency signals.

Short Circuit Transient

Bulk capacitance provides the short-term transient current needed during a hot-attachment event. A 22uF/10V ceramic capacitor mounted close to downstream connect each port should provide transient drop protection

Printed Layout Circuit

The power circuitry of USB printed circuit boards requires a customized layout to maximize thermal dissipation and to minimize voltage drop and EMI

Electrical Characteristics Curve

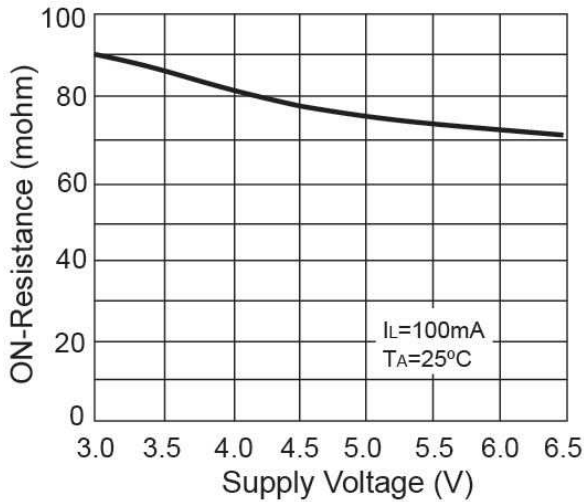

Figure 1. ON Resistance vs. Supply Voltage

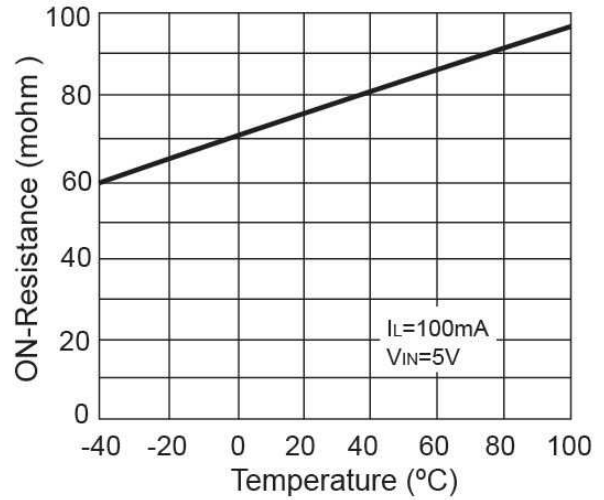

Figure 2. ON Resistance vs. Temperature

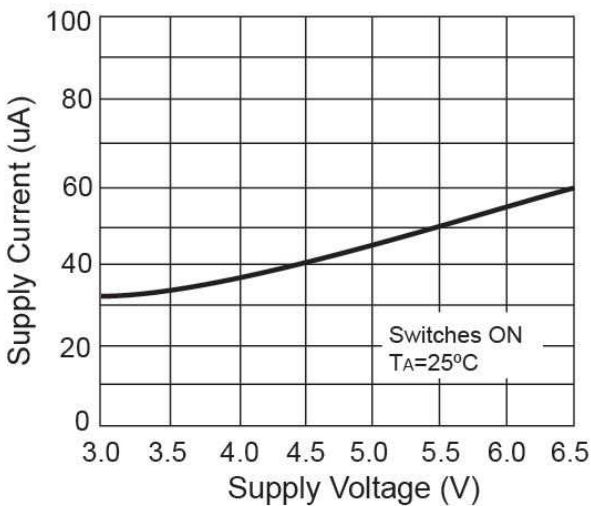

Figure 3. ON-State Current vs. Supply Voltage

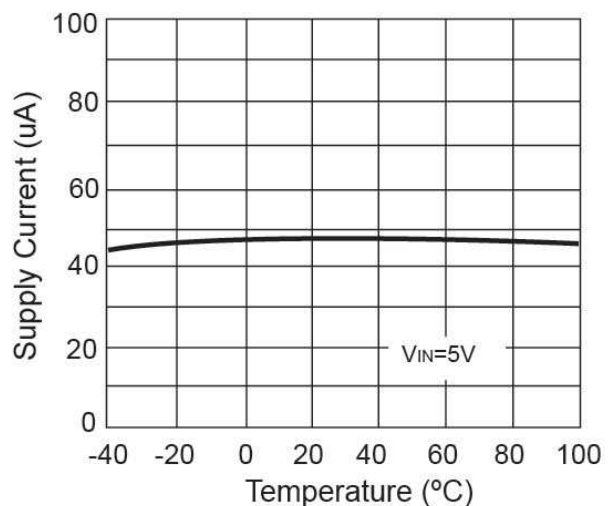

Figure 4. ON-State Current vs. Temperature

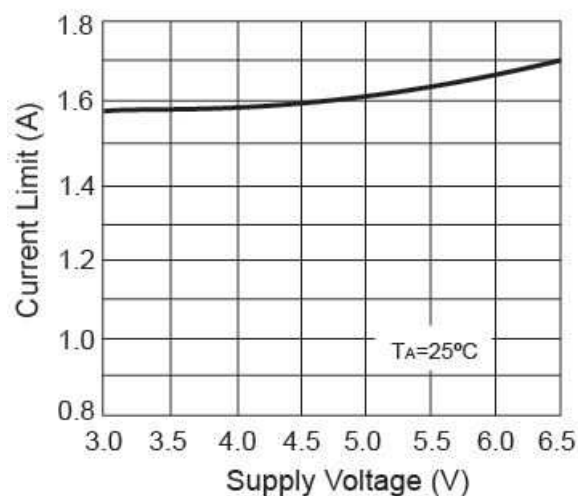

Figure 5. Current Limit vs. Supply Voltage

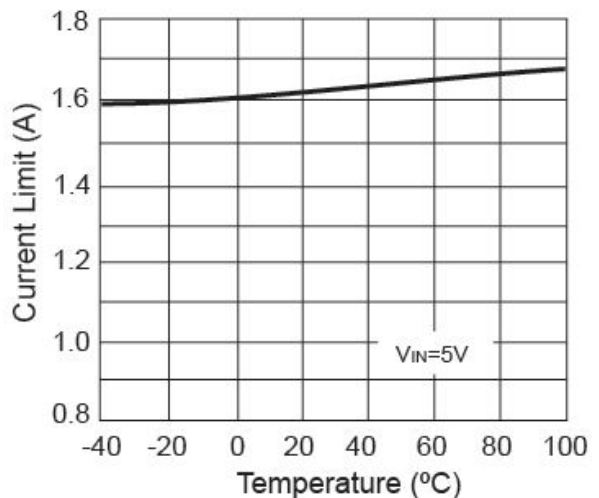

Figure 6. Current Limit vs. Temperature

Electrical Characteristics Curve

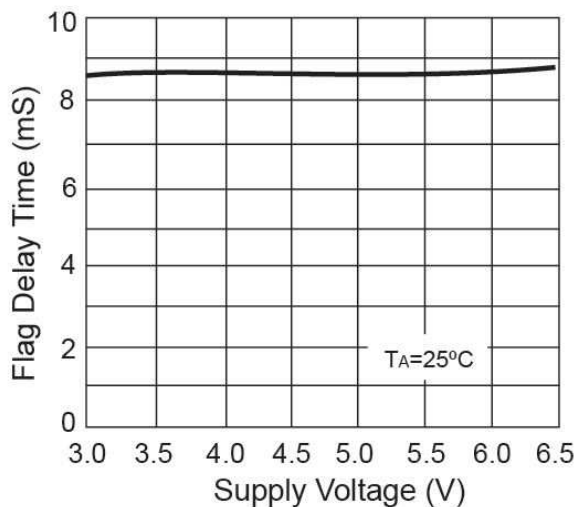

Figure 7. Flag Delay Time vs. Supply Voltage

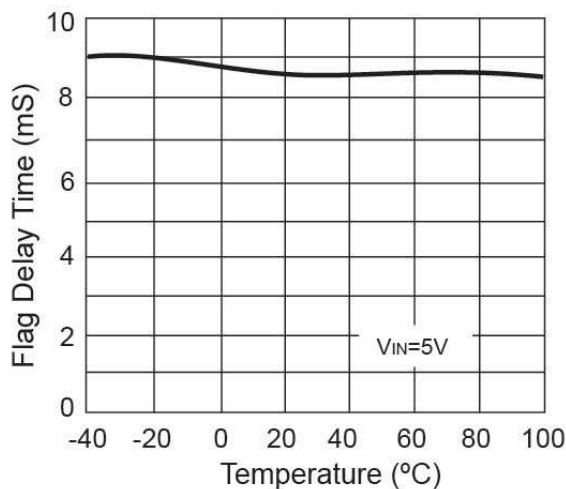

Figure 8. Flag Delay Time vs. Temperature

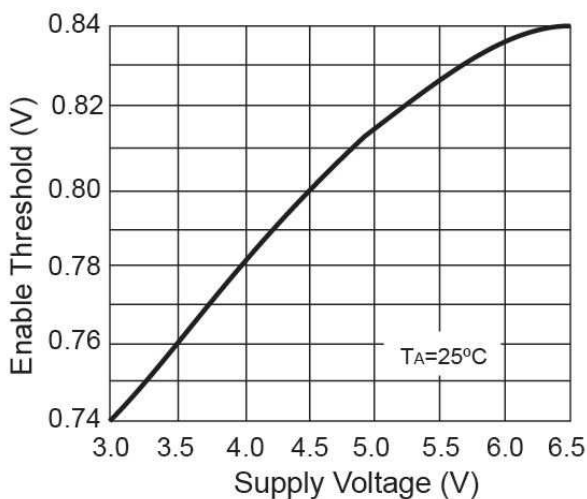

Figure 9. Enable Threshold vs. Supply Voltage

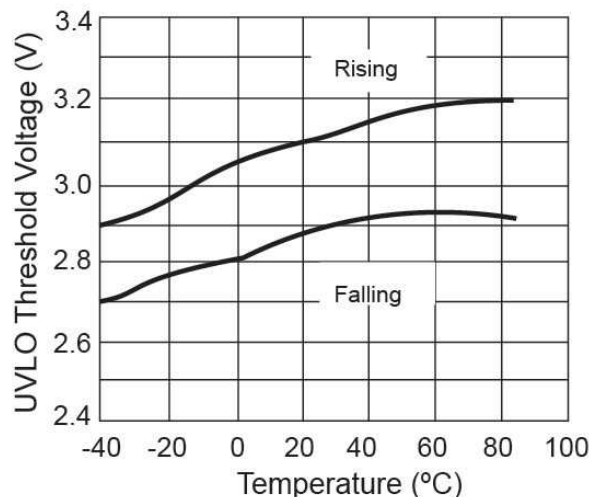

Figure 10. UVLO Threshold vs. Temperature

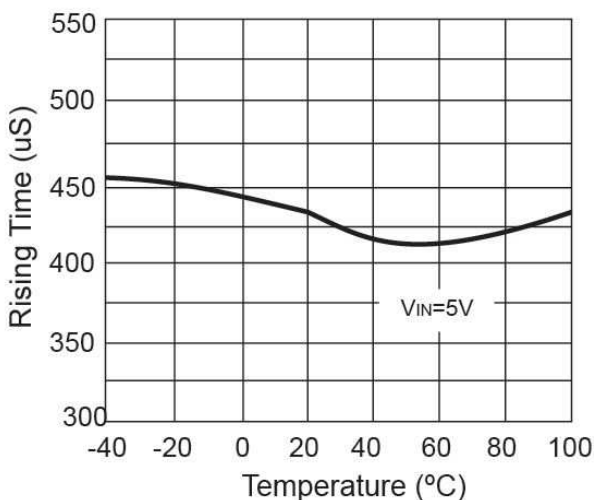
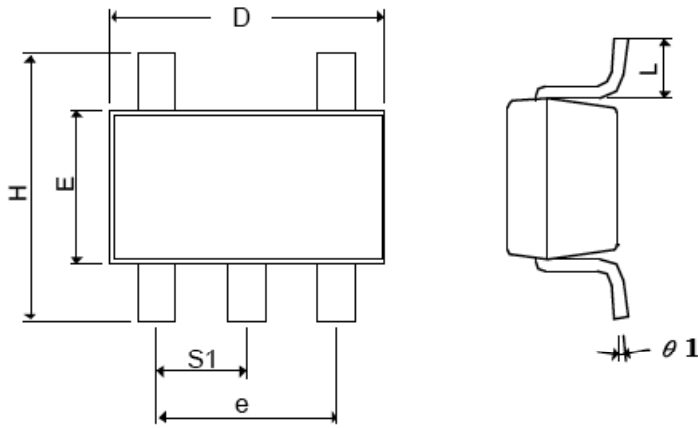

Figure 11. Rising Time vs. Supply Voltage

SOT-25 Mechanical Drawing



SOT-25 DIMENSION				
DIM	MILLIMETERS		INCHES	
	MIN	MAX	MIN	MAX.
A+A1	0.09	1.25	0.0354	0.0492
B	0.30	0.50	0.0118	0.0197
C	0.09	0.25	0.0035	0.0098
D	2.70	3.10	0.1063	0.1220
E	1.40	1.80	0.0551	0.0709
e	1.90 BSC		0.0748 BSC	
H	2.40	3.00	0.09449	0.1181
L	0.35 BSC		0.0138 BSC	
Ø1	0°	10°	0°	10°
S1	0.95 BSC		0.0374 BSC	

Front View

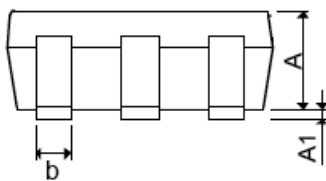

Notice

Specifications of the products displayed herein are subject to change without notice. TSC or anyone on its behalf, assumes no responsibility or liability for any errors or inaccuracies.

Information contained herein is intended to provide a product description only. No license, express or implied, to any intellectual property rights is granted by this document. Except as provided in TSC's terms and conditions of sale for such products, TSC assumes no liability whatsoever, and disclaims any express or implied warranty, relating to sale and/or use of TSC products including liability or warranties relating to fitness for a particular purpose, merchantability, or infringement of any patent, copyright, or other intellectual property right.

The products shown herein are not designed for use in medical, life-saving, or life-sustaining applications. Customers using or selling these products for use in such applications do so at their own risk and agree to fully indemnify TSC for any damages resulting from such improper use or sale.